

MONTÁŽNY NÁVOD

videri

PROFESSIONAL AUTOMATION

MONTÁŽNY NÁVOD PRE UNIVERZÁLNY PRIJÍMAČ RX-MULTI

**Technické údaje:**

Frekvencia: 433 – 868MHz (MULTI)
 Napájanie: 12V – 30V AC/DC
 Krabička externá s anténou
 Typ kódu: Plávajúci, pevný kód
 Rozmery: 5,5cm x 4,5cm x 2cm (d' x š x v)
 Váha: 40g

PRIJÍMAČ RX - MULTI

Pomocou 8 DIP – switchov, môže užívateľ nastaviť prijímač pre požadovanú značku vysielateľa.

Kombinácie prepínačov pre jednotlivé značky vysielateľov sú uvedené v tabuľke.

Prijímač RX-MULTI je dvoj-kanálový, každý kanál má nezávislé tlačidlo učenia.

Kanáľ 1: tlačidlo S1 / LED L1

Kanáľ 2: tlačidlo S2 / LED L2

Prijímač RX MULTI môže byť napájaný napätím AC/DC 9V – 30V.

Doporučuje sa nastaviť prepínač podľa vstupného napätia.

1. Ak má napájacie napätie vyššiu hodnotu ako 24V, je potrebné prepojiť PIN 2&3
2. Ak má napájacie napätie nižšiu hodnotu ako 24V, je potrebné prepojiť PIN 1&2

Prijímač obsahuje pamäťovú kartu, ktorú je možné vybrať pre čítanie, kopírovanie a zálohovanie kódov.

Programovanie vysieláčov:

1. Najskôr vyberte správnu značku diaľkového ovládača, ktorý chcete naladiť (nastavte DIP-Switch podľa tabuľky vybraného ovládača)

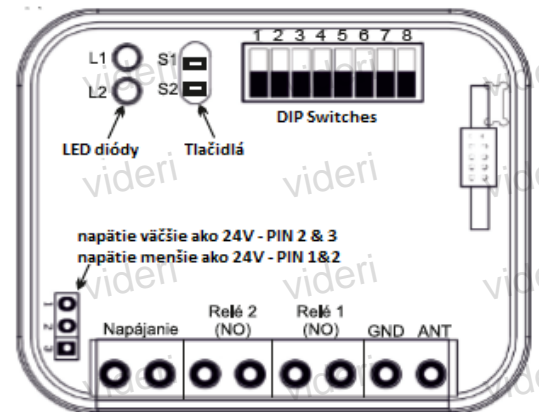

MONTÁŽNY NÁVOD

2. Stlačte tlačidlo 1. kanála na 2 sekundy, LED zostane svietiť.

Stlačte tlačidlo na vysielacom, LED S1 4x zabliká, týmto je ovládač naladený





































3. V prípade potreby naladenia ďalšieho tlačidla vysielacza,, opakujte krok 2

Mazanie vysieláčov z pamäti prijímača:

Stlačte a podržte tlačidlo učenia, kontrolka LED začne blikať. Držte toto tlačidlo stlačené, kým sa LED nevyhne.

Všetky údaje na pamäťovej karte budú vymazané.

Pozor: po vymazaní pamäťovej karty nie je možné údaje obnoviť!!

Por. číslo	Výber prepínača	Značka	Frekvencia	Poznámka	Por. číslo	Výber prepínača	Značka	Frekvencia	Poznámka
1		NICE FLORS	433,92MHz		24		SOMMER	868,8MHz	
2		MARANTEC	433,92MHz		25		LIFTMASTER ROLLING CODE	868MHz	
3		MARANTEC	868,3MHz		26		CLEMSA MASTERCODE	433,92MHz	
4		UNIVERZÁL. PEVNÝ KÓD	433,92MHz	PEVNÝ KÓD	27		DITEC	315MHz	
5		FAAC SLH ROLLING CODE	433,92MHz		28		DITEC	390MHz	
6		LIFTMASTER	310MHz		29		DITEC	433,92MHz	
7		LIFTMASTER	390MHz		30		V2	315MHz	
8		LIFTMASTER	433,92MHz		31		V2	390MHz	
9		UNIVERZÁL. ROLLING OPEN CODE	433,92MHz	OPEN CODE	32		V2	433,92MHz	
10		UNIVERZÁL. ROLLING OPEN CODE	315MHz	OPEN CODE	33		APRIMATIC ROLLING CODE	433,92MHz	

MONTÁŽNY NÁVOD

11		UNIVERZÁL. ROLLING OPEN CODE	318MHz	OPEN CODE	34		APRIMATIC ROLLING CODE	868,3MHz	
12		UNIVERZÁL. PEVNÝ KÓD	300MHz	PEVNÝ KÓD	35		JCM GO ROLLING CODE	868,3MHz	
13		UNIVERZÁL. PEVNÝ KÓD	310MHz	PEVNÝ KÓD	36		JCM TECH ROLLING CODE	868,3MHz	
14		UNIVERZÁL. PEVNÝ KÓD	315MHz	PEVNÝ KÓD	37		P.N.C. ROLLING CODE	868,3MHz	
15		UNIVERZÁL. PEVNÝ KÓD	318MHz	PEVNÝ KÓD	38		MAP ROLLING CODE	868,3MHz	
16		UNIVERZÁL. PEVNÝ KÓD	330MHz	PEVNÝ KÓD	39		FORSA	868,3MHz	
17		UNIVERZÁL. PEVNÝ KÓD	390MHz	PEVNÝ KÓD	40		SOMMER	434,4MHz	
18		LIFTMASTER ROLLING CODE BILLION CODE	390MHz		41		DMIL	868,3MHz	
19		LIFTMASTER ROLLING CODE BILLION CODE	315MHz		42		CEA	868,3MHz	
20		HORMANN MARANTEC BERNER	868MHz		43		ROPER	868,3MHz	
21		FAAC SLH	868MHz		44		UNIVERZÁL ROLLING CODE FSK	868MHz	OPEN CODE
22		PRASTEL	433,92MHz		45		UNIVERZÁL ROLLING CODE ASK	868MHz	OPEN CODE